

# Bioloģijas laboratorijas eksperimenta veidošanas un demonstrēšanas metodika Biol4296

## Iekārtu savienošana

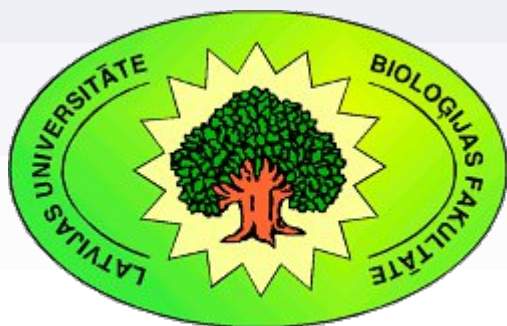

*Kārlis Kalviškis, LU Bioloģijas fakultāte*

*2014. gada 15. oktobrī*

# Kopēji ieteikumi

- Pirms sāk kaut ko vienot, iepazīsties ar iekārtu aprakstiem.
- Pievienojot iekārtas nevajag lietot pārmērīgu spēku – iespējams, ka esi izvēlējies nepareizu kabeli!
- Pēc izskata ne vienmēr var pateikt, ko iespējams pievienot dotajam datoram.

# Atrunas

- Šeit apskatītie pieslēguma veidi ir tikai maza daļiņa no tiem, ar kādiem var nākties sastapties.

# Bioloģijas laboratorijas eksperimenta veidošanas un demonstrēšanas metodika Biol4296

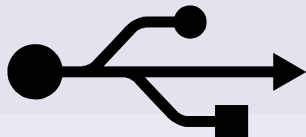

USB

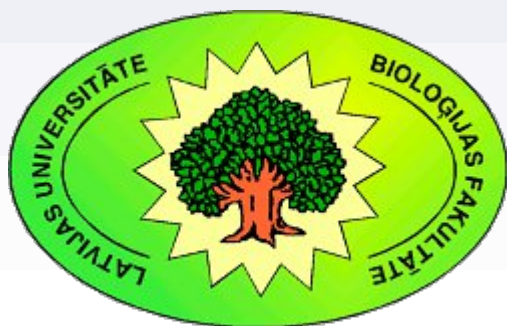

*Kārlis Kalviškis, LU Bioloģijas fakultāte*

*2014. gada 15. oktobrī*



# USB

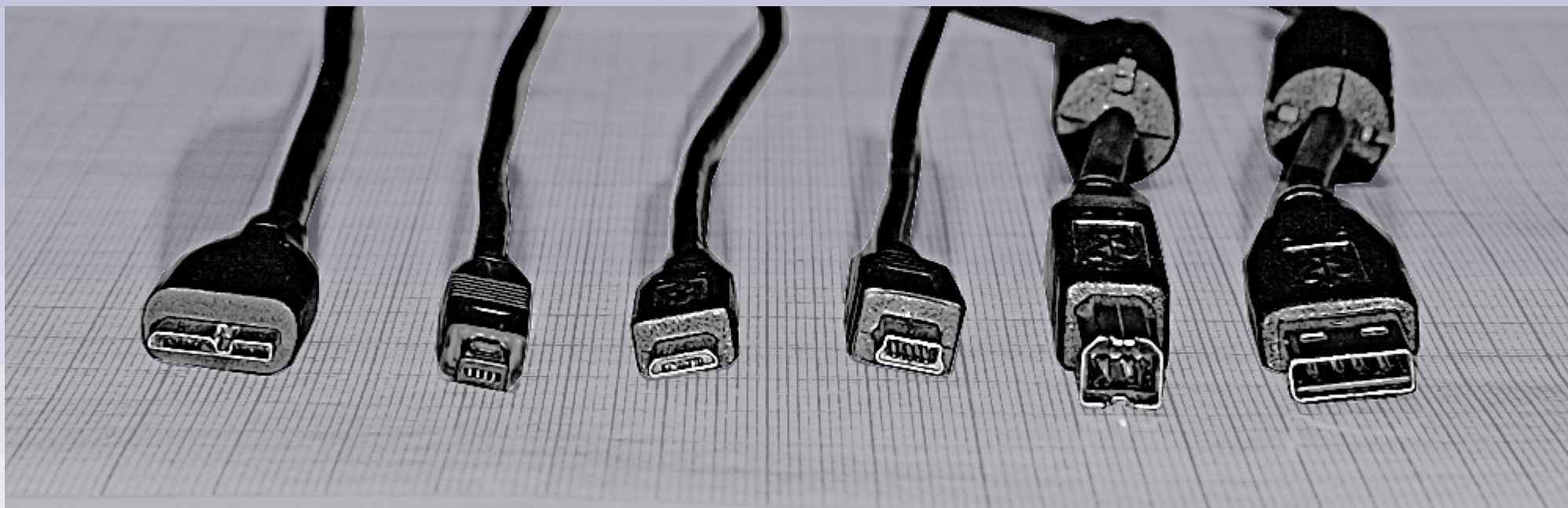

*USB 3*



<http://www.techworld.com/cmsdata/news/3210229/USB%20%20cable.jpg>



# USB ar papildus barošanu



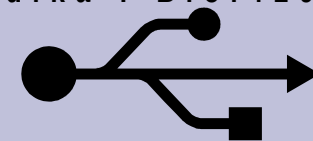

# USB -> COM: (RS-232)





# USB -> LPT: (IEEE 1284)





# Bioloģijas laboratorijas eksperimenta veidošanas un demonstrēšanas metodika Biol4296

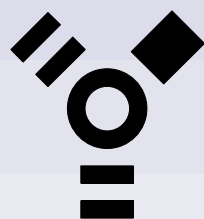

Firewire (IEEE 1394)

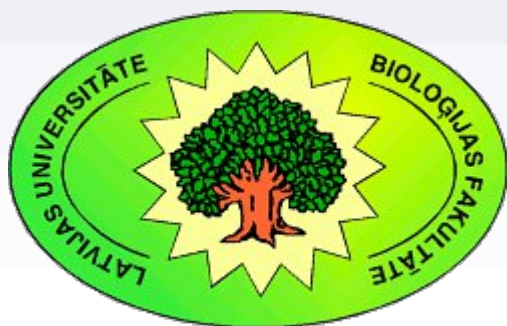

*Kārlis Kalviškis, LU Bioloģijas fakultāte*

*2014. gada 15. oktobrī*

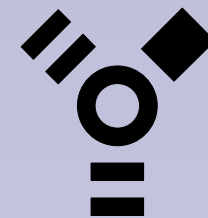

# Firewire (IEEE 1394)



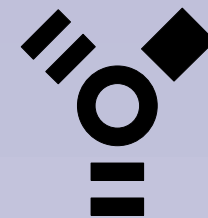

# Firewire (IEEE 1394)



*Nav  
barošanas !*



# Bioloģijas laboratorijas eksperimenta veidošanas un demonstrēšanas metodika Biol4296



Datora monitori

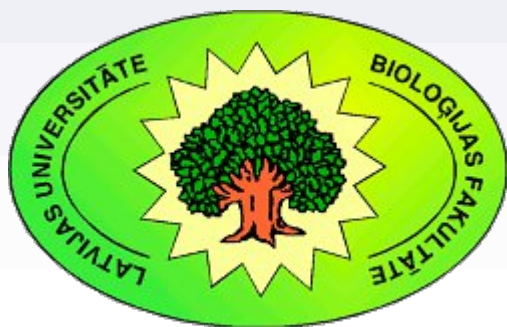

*Kārlis Kalviškis, LU Bioloģijas fakultāte*

*2014. gada 15. oktobrī*

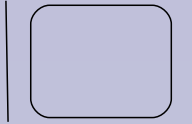

# Monitoru porti

*VGA*



*Mini-VGA*



*DVI*



*Mini-DVI*



*Micro-DVI*



*Display Port*



*Mini Display Port*



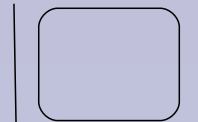

# DVI dažādība

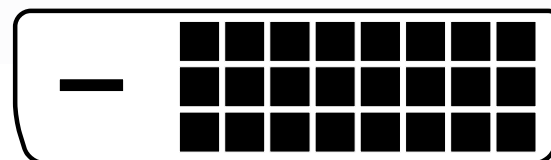
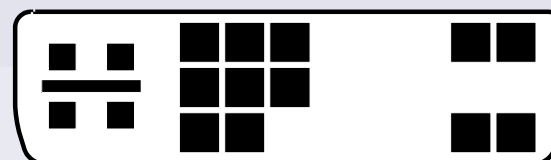
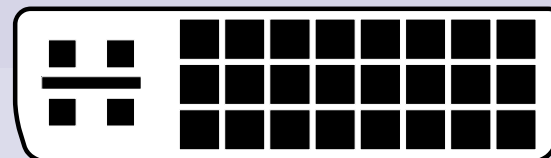
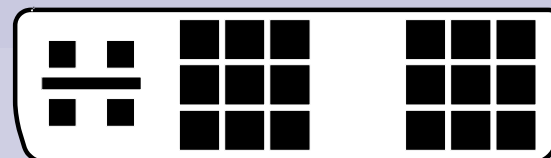

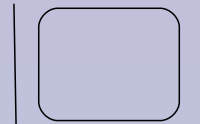

# DVI -> VGA





# DVI -> VGA

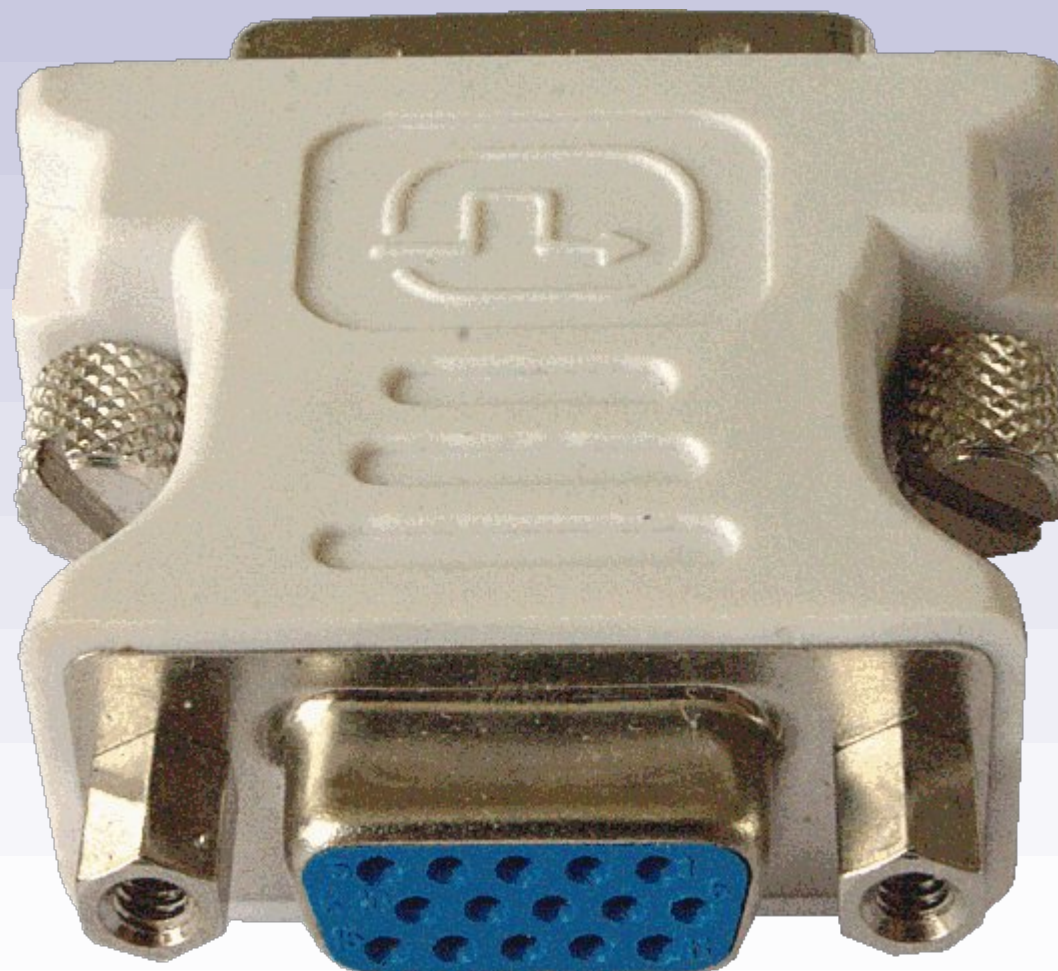



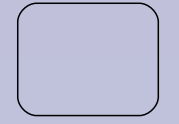

# Monitoru porti

*Low Force Helix  
DMS-59*





# Monitoru porti

*Low Force Helix  
DMS-59*

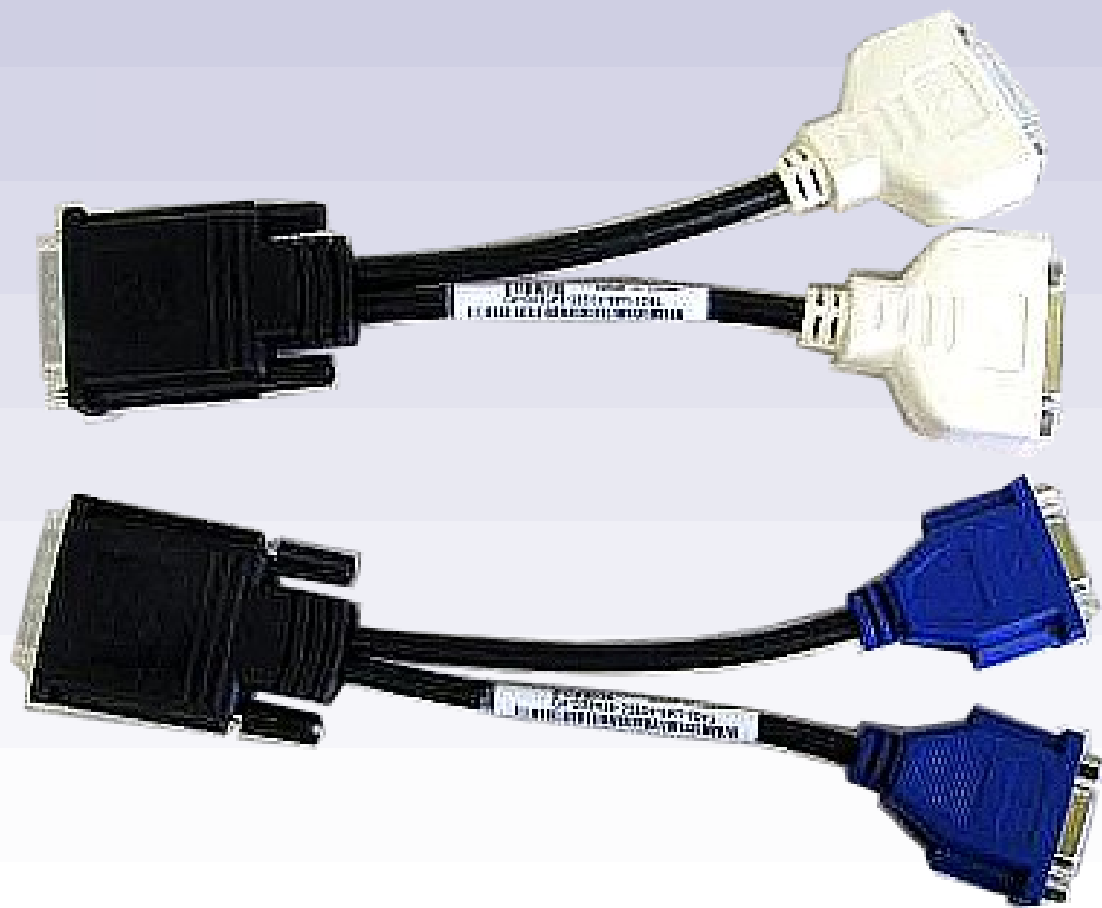

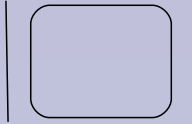

# *LCD* projektorā pievienošana *Mak*-am





# *LCD* projektora pievienošana *Mak*-am

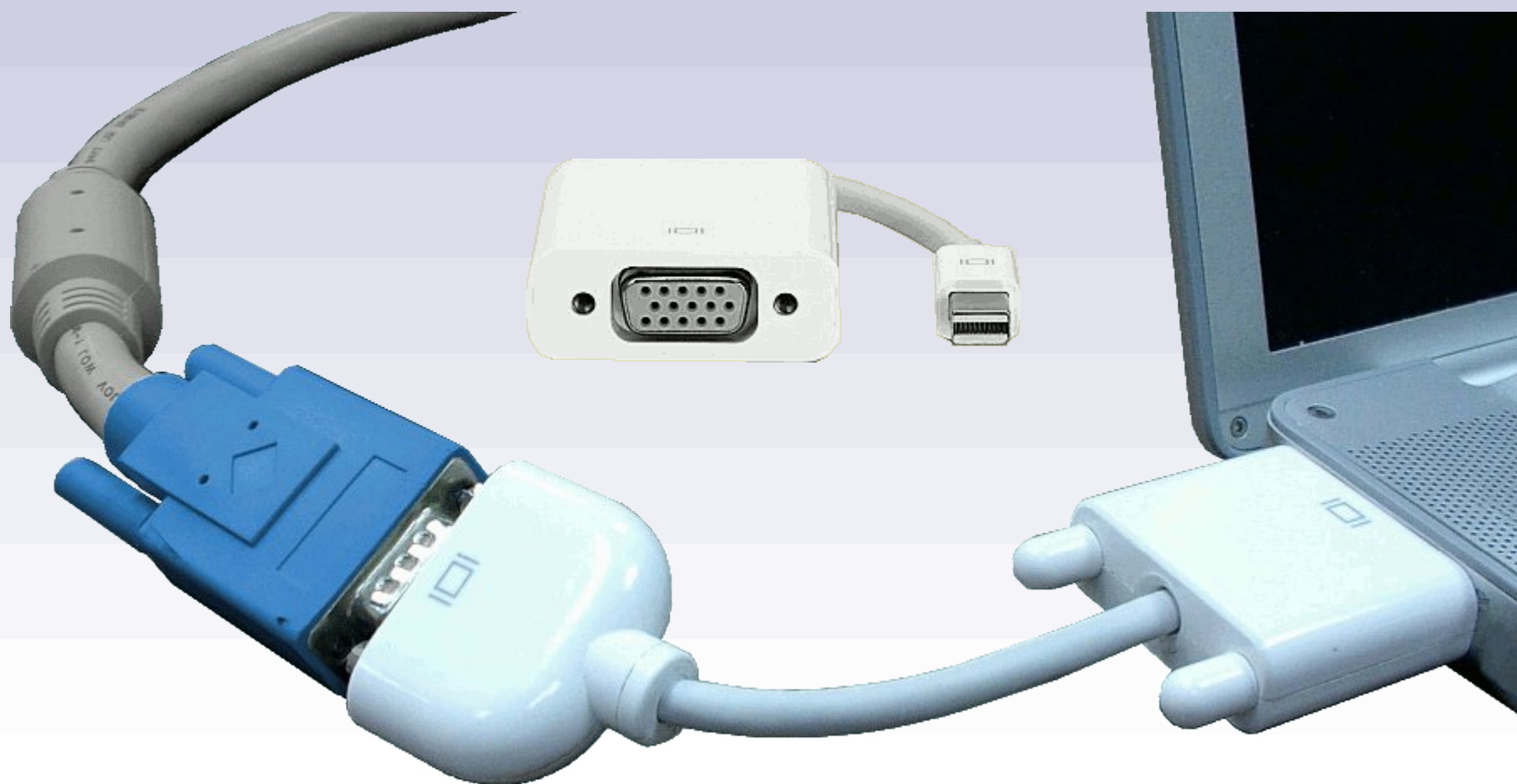

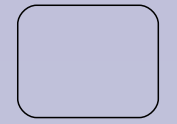

# HDMI

- *High-Definition Multimedia Interface*

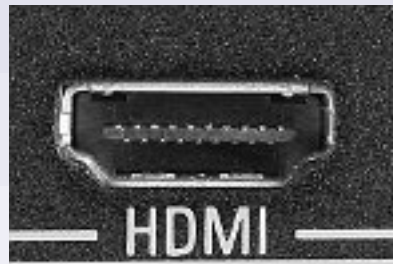

# Bioloģijas laboratorijas eksperimenta veidošanas un demonstrēšanas metodika Biol4296



## Audio/Video

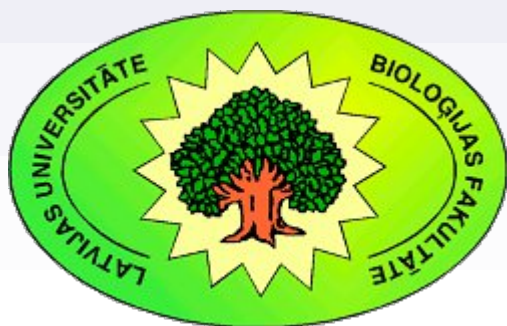

*Kārlis Kalviškis, LU Bioloģijas fakultāte*

*2014. gada 15. oktobrī*

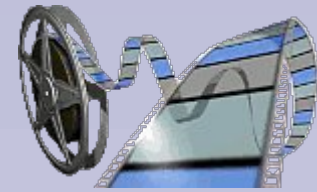

# SCART

- *Syndicat des Constructeurs d'Appareils Radiorécepteurs et Téléviseurs.*

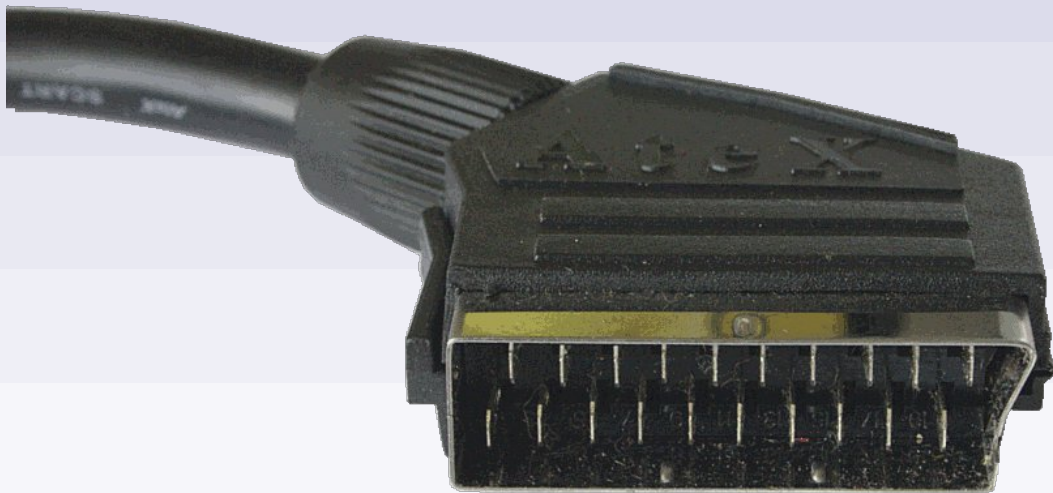

# SCART <-> S-Video, C-Video

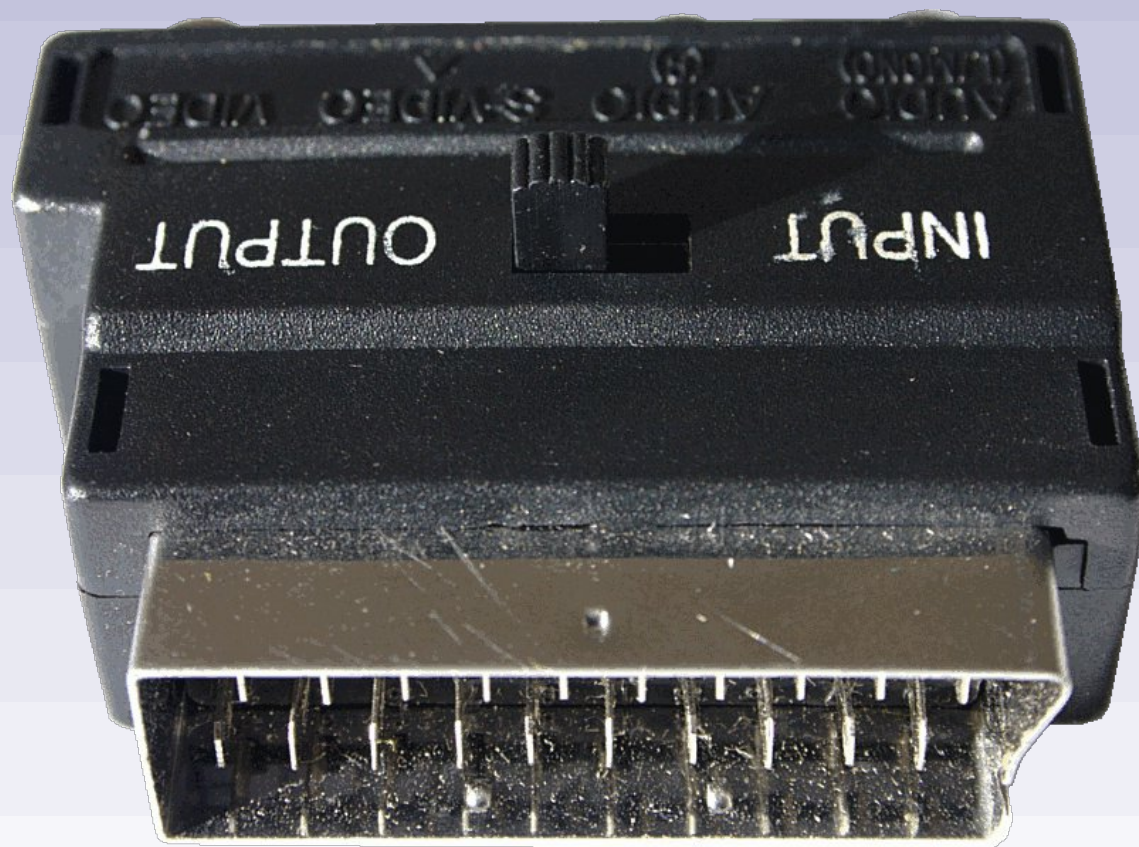
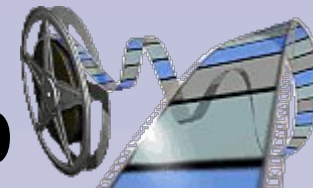



# SCART <-> S-Video, C-Video

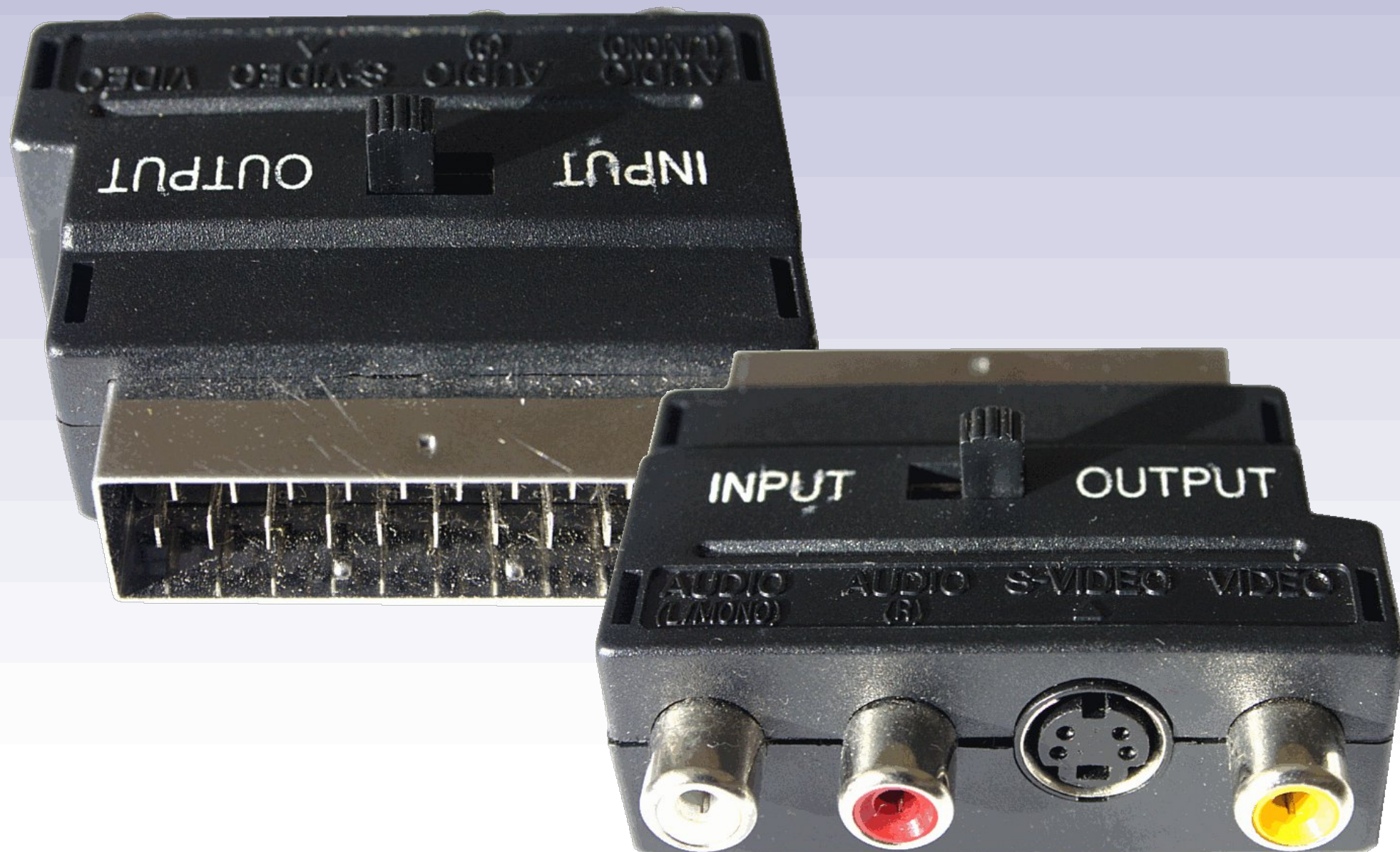
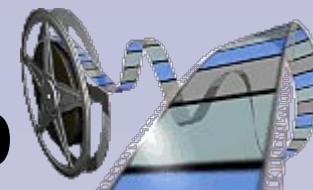

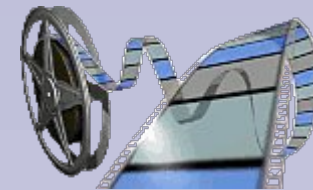

# S-Video, C-Video

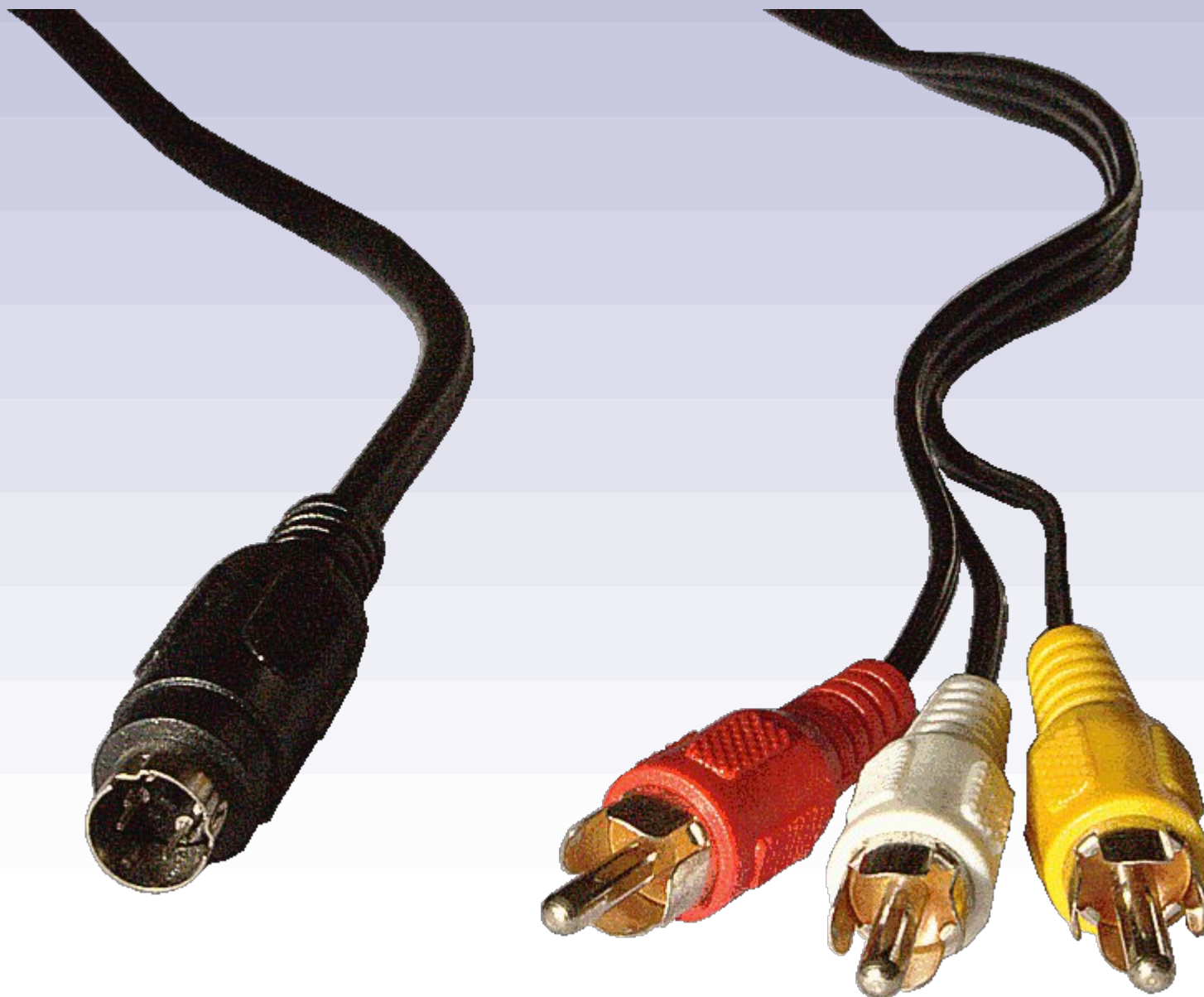

# S-Video -> C-Video

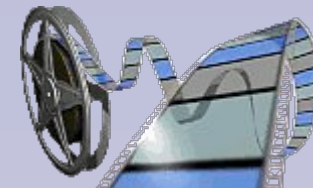

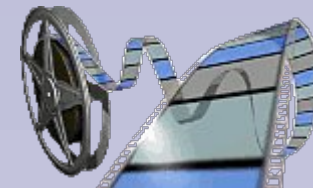

# S-Video -> C-Video

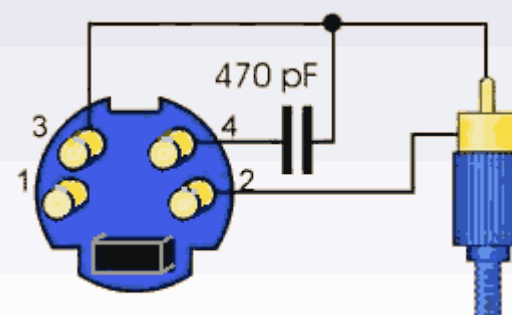

# Video In Video Out (VIVO)

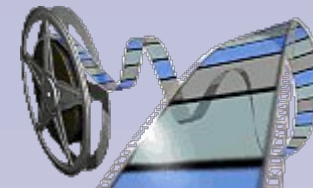

# Daži audio savienotāji



# Datora audio ieejas/izejas

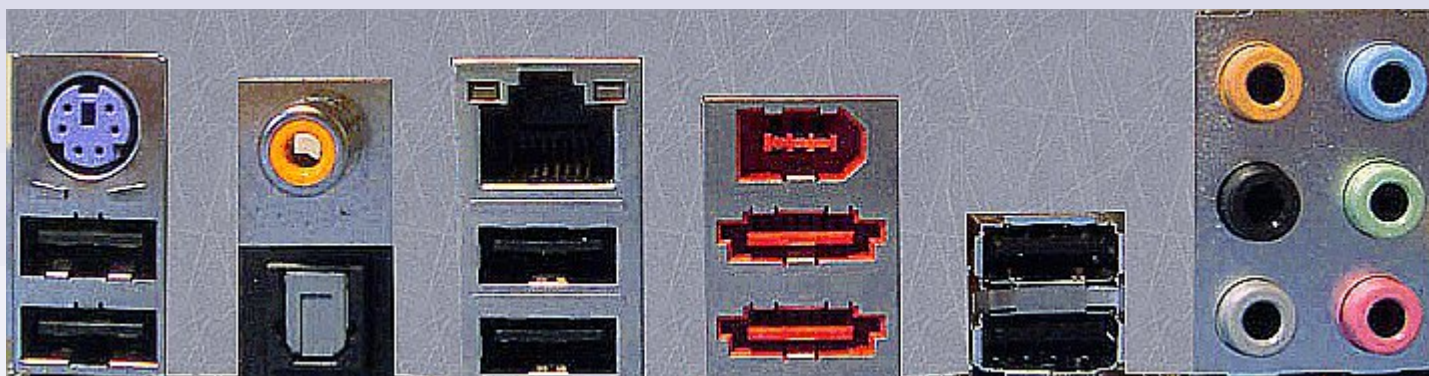



# Datora audio ieejas/izejas

*Analogie  
signāli*

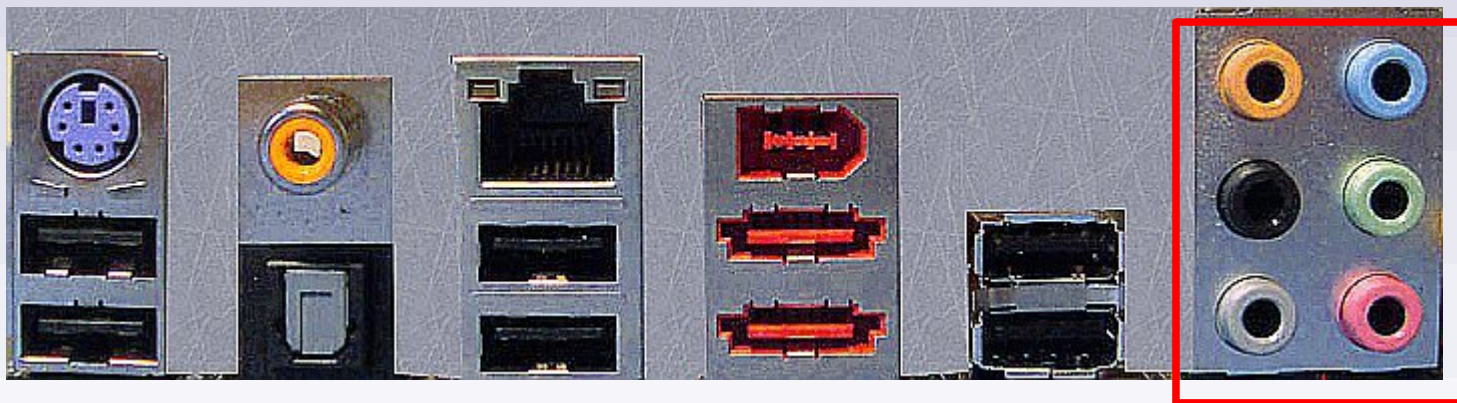





# Datora audio ieejas/izejas

*Digitālie  
signāli (S/PDIF)*

*Analogie  
signāli*

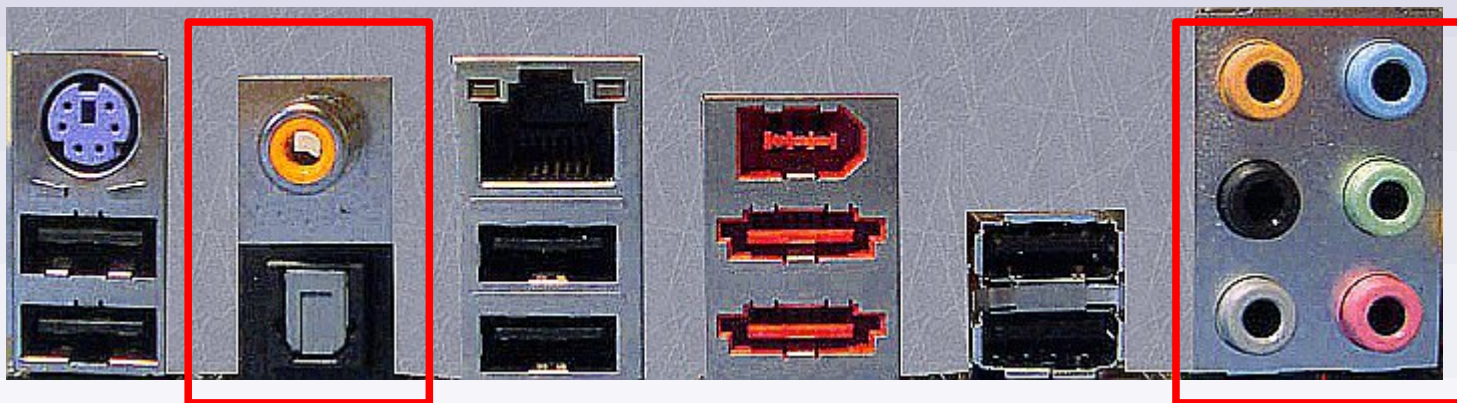



# Datora audio ieejas/izejas

*Digitālie  
signāli (S/PDIF)*

*Analogie  
signāli*

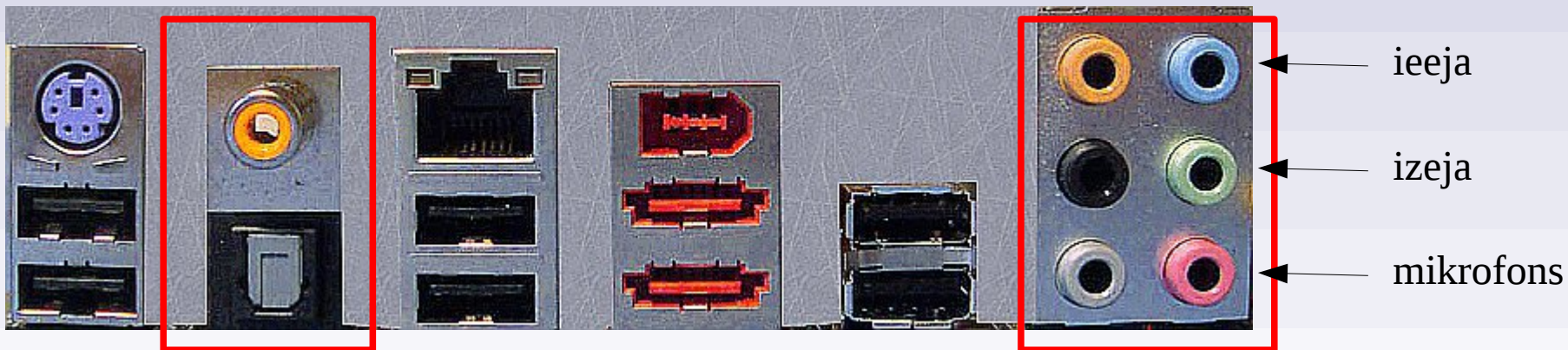



# Datora audio ieejas/izejas

*Digitālie  
signāli (S/PDIF)*

*Analogie  
signāli*

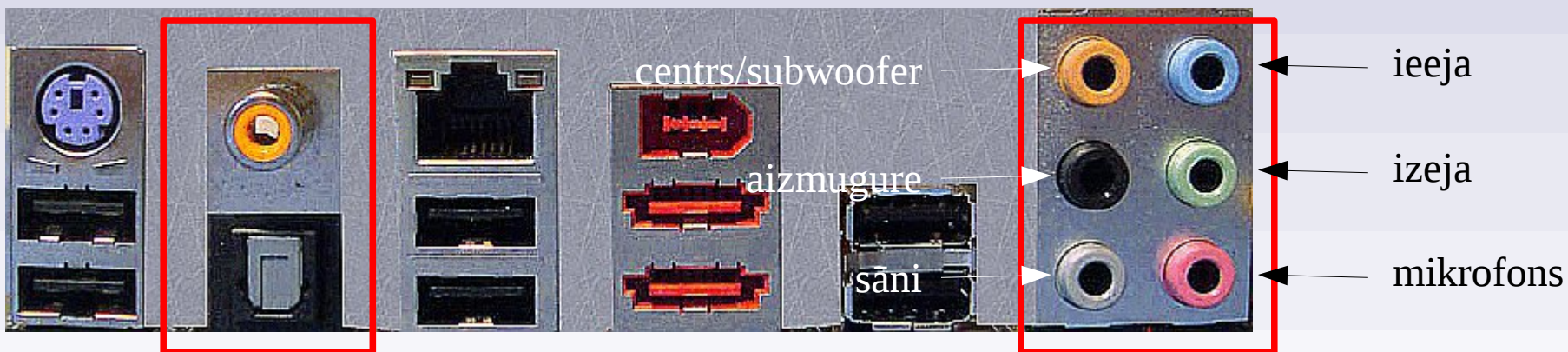



# Datora audio ieejas/izejas

*Digitālie  
signāli (S/PDIF)*

*Analogie  
signāli*

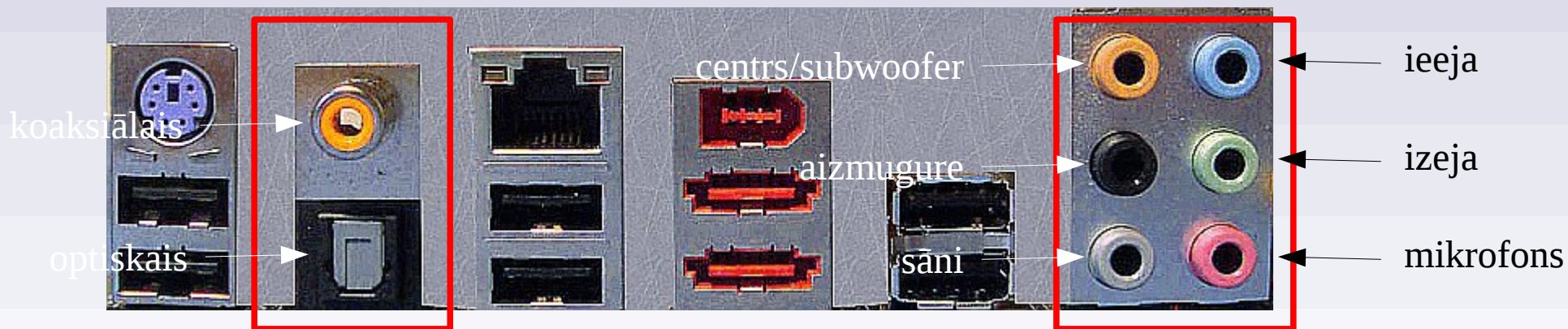

# Bioloģijas laboratorijas eksperimenta veidošanas un demonstrēšanas metodika Biol4296

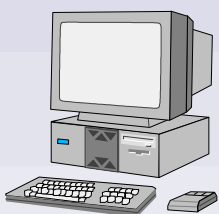

Iekārtas

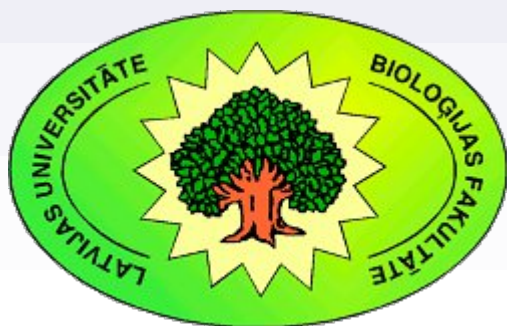

*Kārlis Kalviškis, LU Bioloģijas fakultāte*

*2014. gada 15. oktobrī*

# Digitālās video un fotokameras



# Digitālās video un fotokameras

- Ja iespējams, labāk izmantot Firewire (IEEE 1394).



# Digitālās video un fotokameras

- Ja iespējams, labāk izmantot Firewire (IEEE 1394).
- Parastā video kabelis:





# Atmiņu karšu lasītāji

- Fotogrāfijas no digitālās kameras ērti un ātri var pārkopēt datorā izmantojot atmiņas karšu lasītāju.



# Bioloģijas laboratorijas eksperimenta veidošanas un demonstrēšanas metodika Biol4296

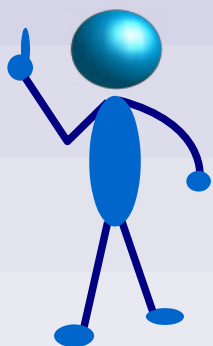

Portu līdzīgais izskats

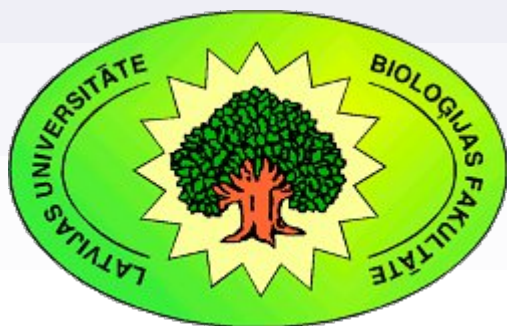

*Kārlis Kalviškis, LU Bioloģijas fakultāte*

*2014. gada 15. oktobrī*

# HDMI, e-Sata, USB, DisplayPort

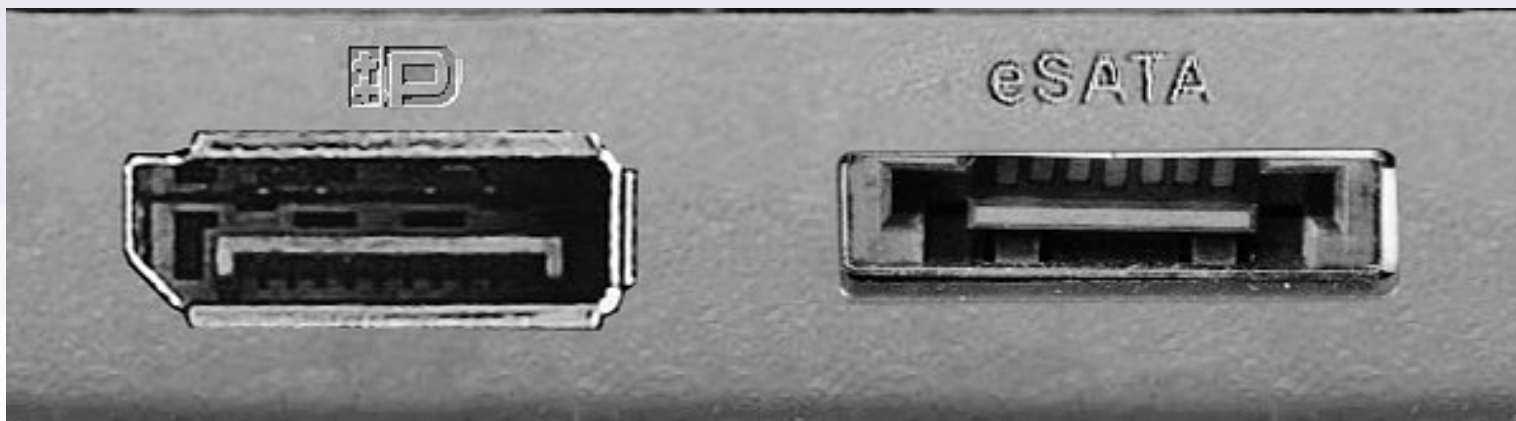
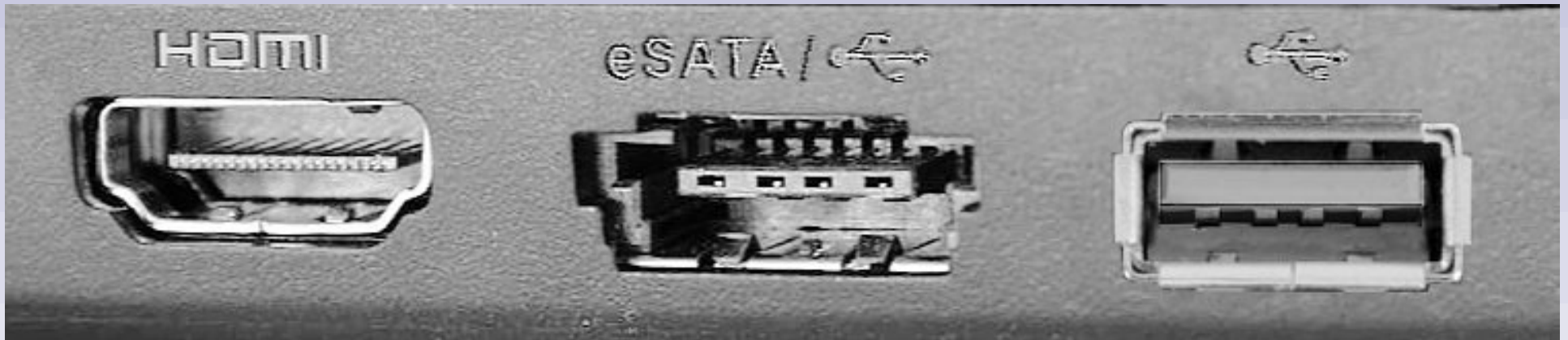

# PS/2, S-Video, nestandarta grafiskais ports

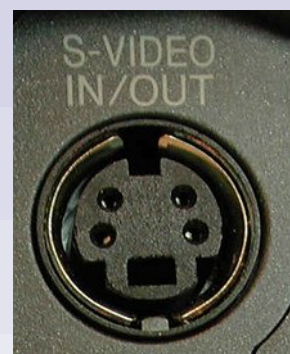

# COM, VGA



# Tālruņa līnija, Datortīkls

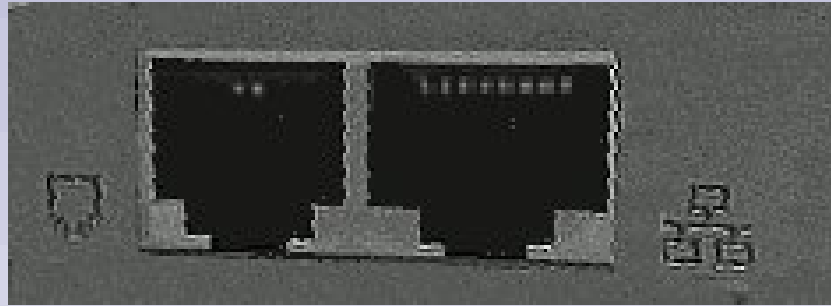

# Tālruņa līnija, Datortīkls

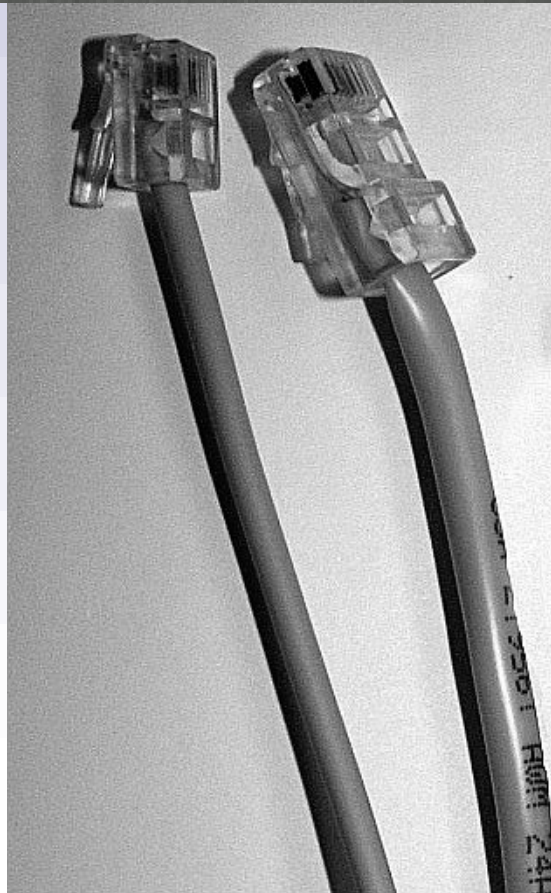
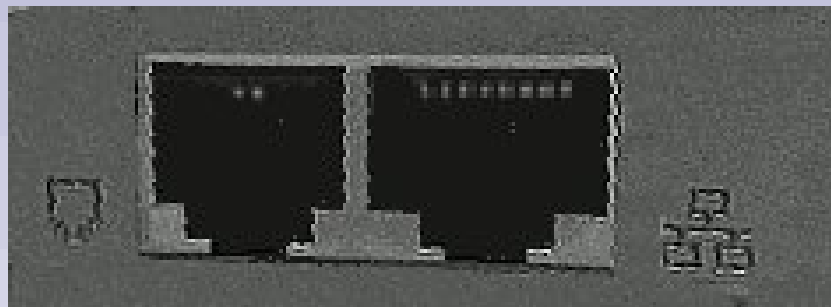

# Tālruņa līnija, Datortīkls

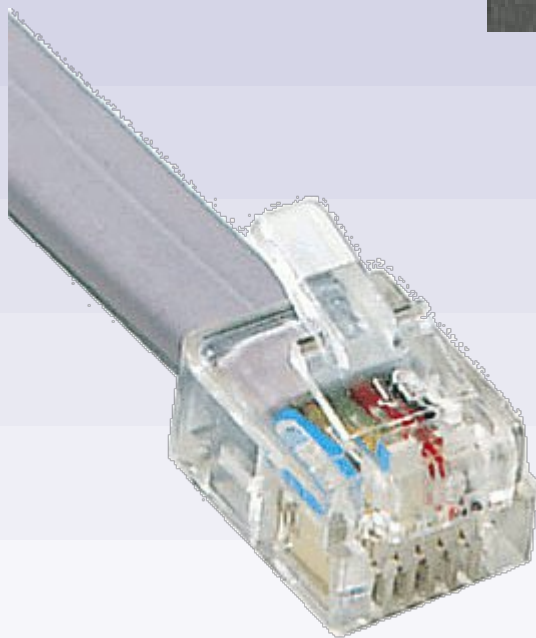
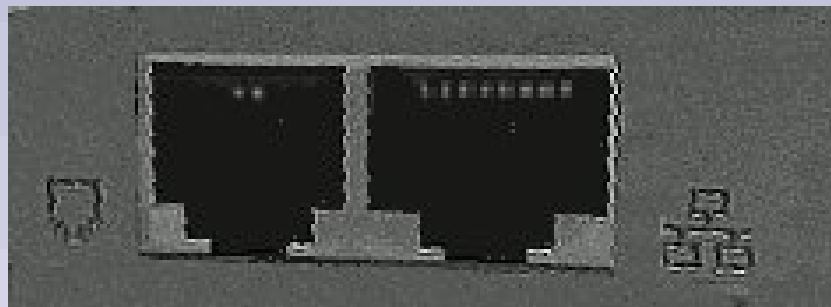

*6 vai 4  
kontakti*

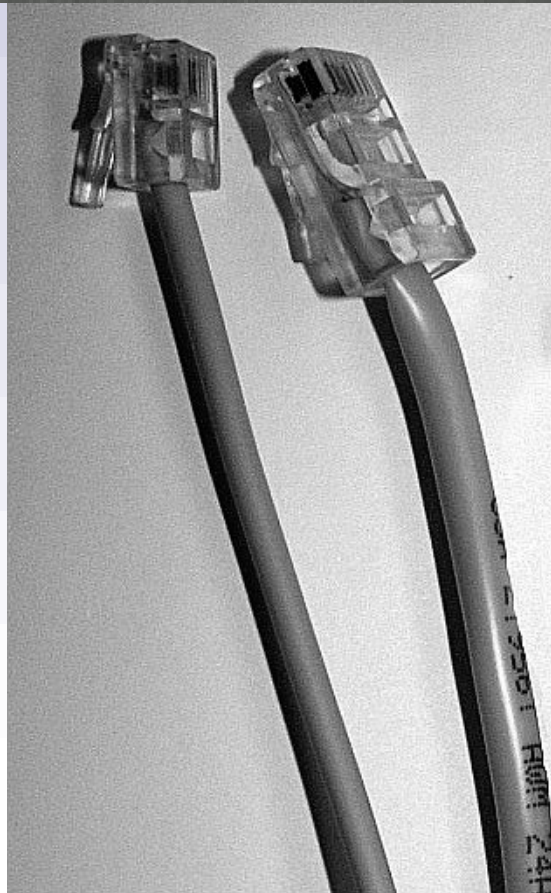



# Tālruņa līnija, Datortīkls

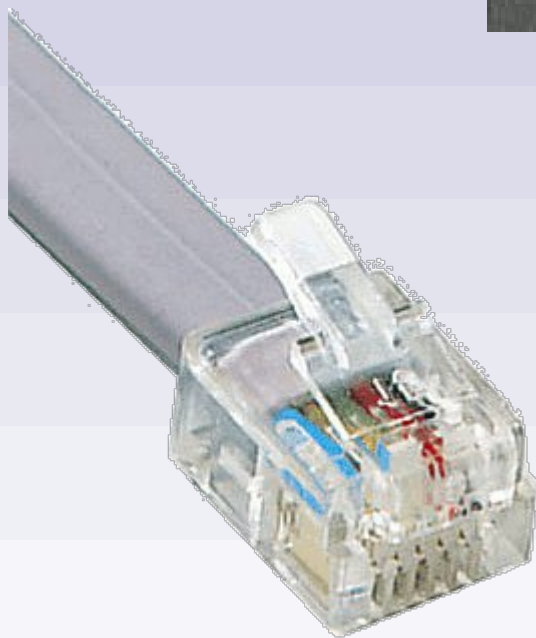
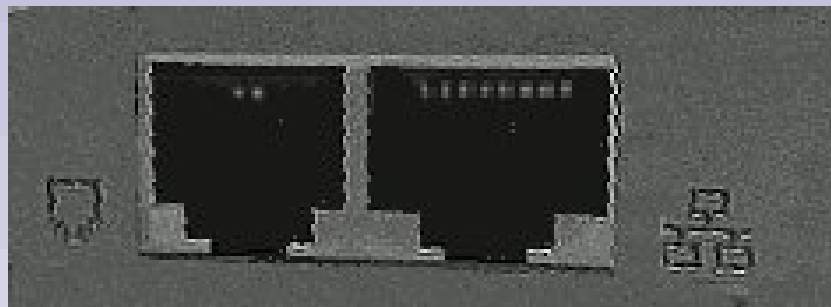

*6 vai 4  
kontakti*

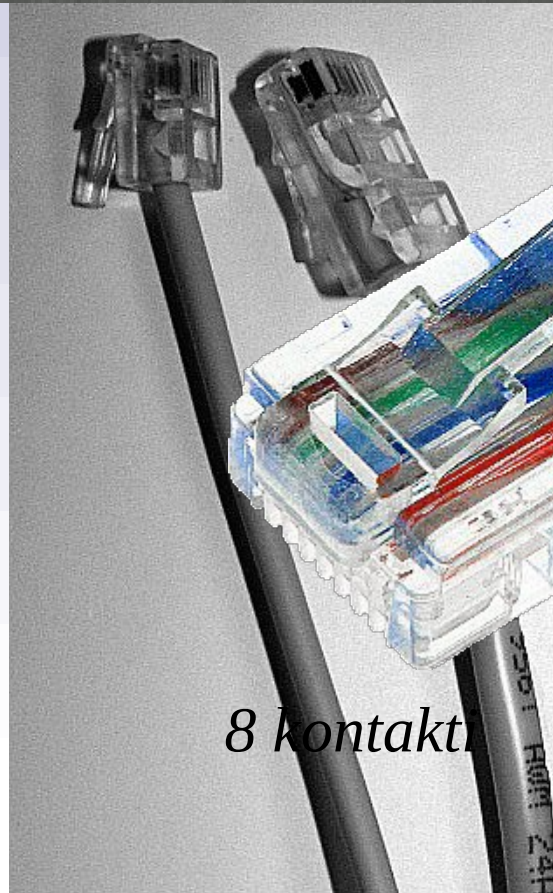

*8 kontakti*

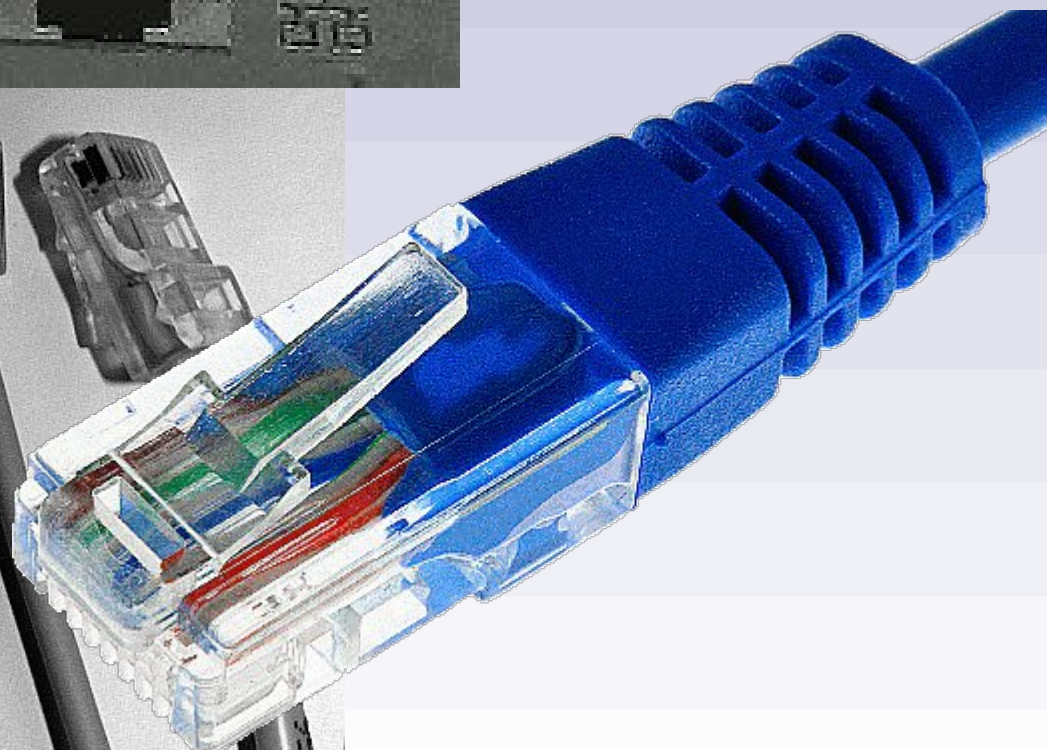

# „Daudzdimensionāli” vadi ;-)

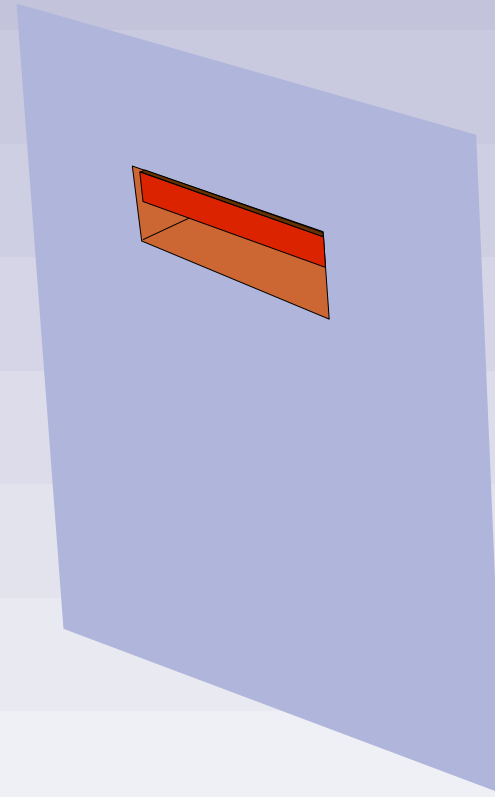

# „Daudzdimensionāli” vadi ;-)

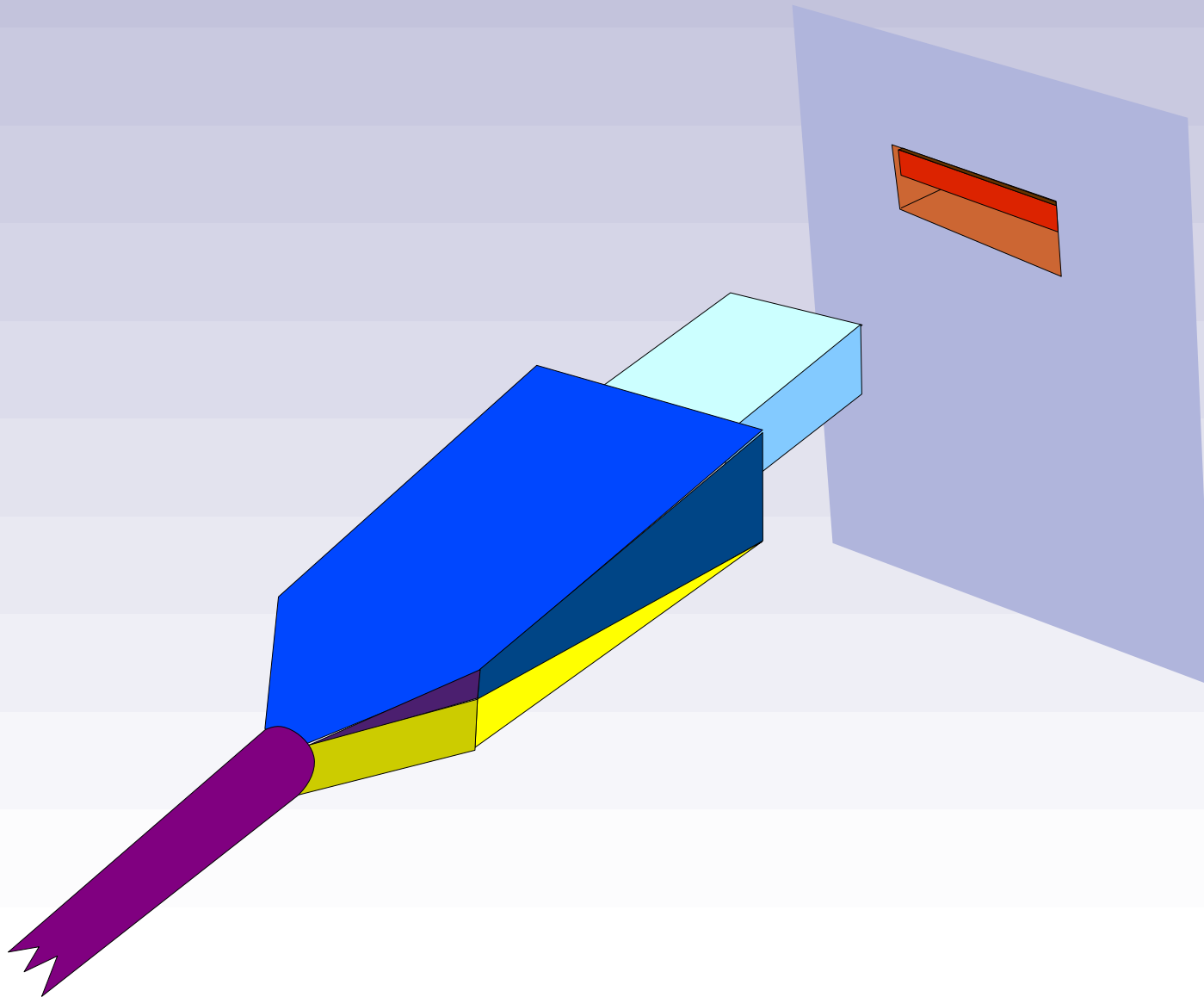

# „Daudzdimensionāli” vadi ;-)

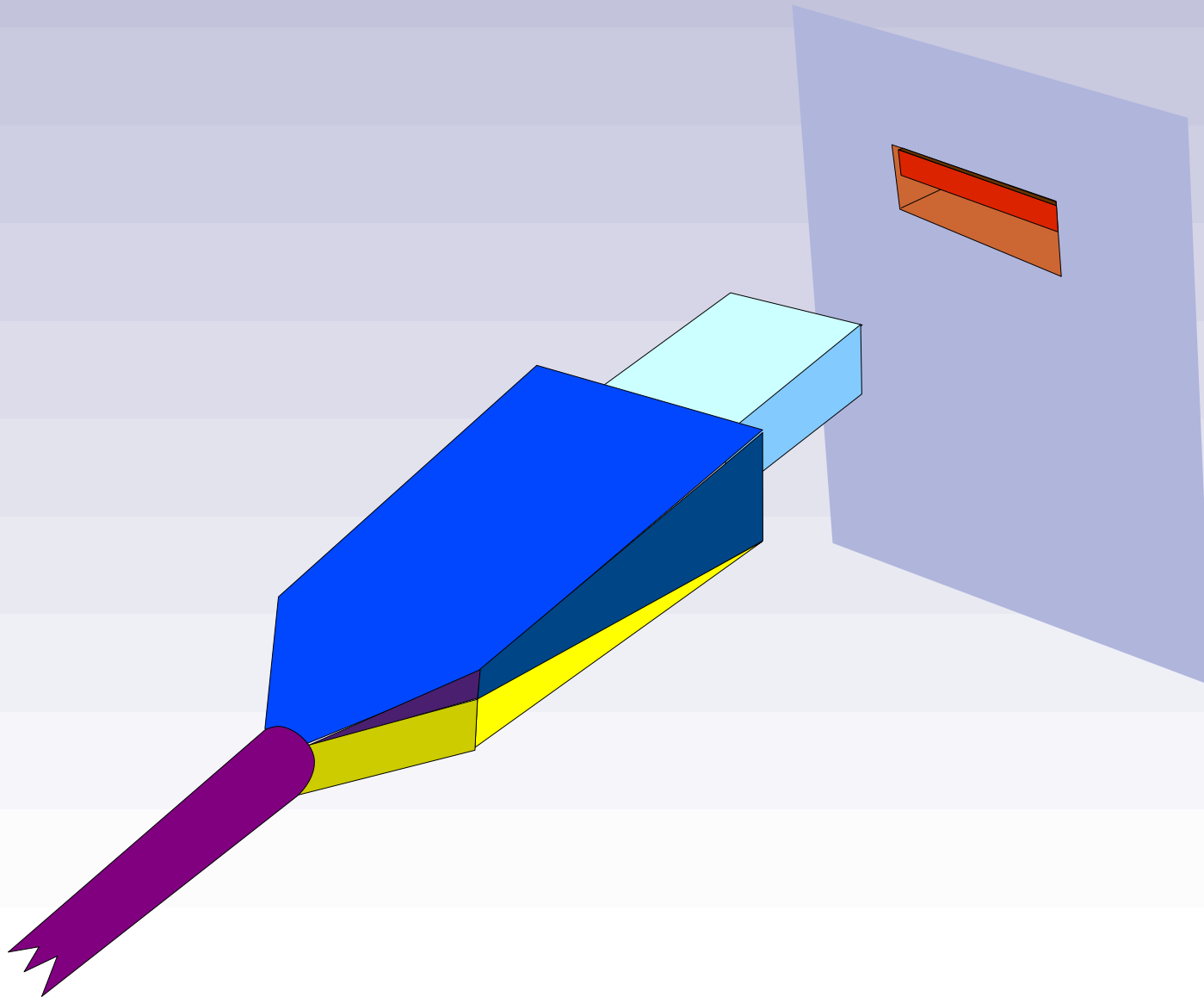

# „Daudzdimensionāli” vadi ;-)

*Neder!*

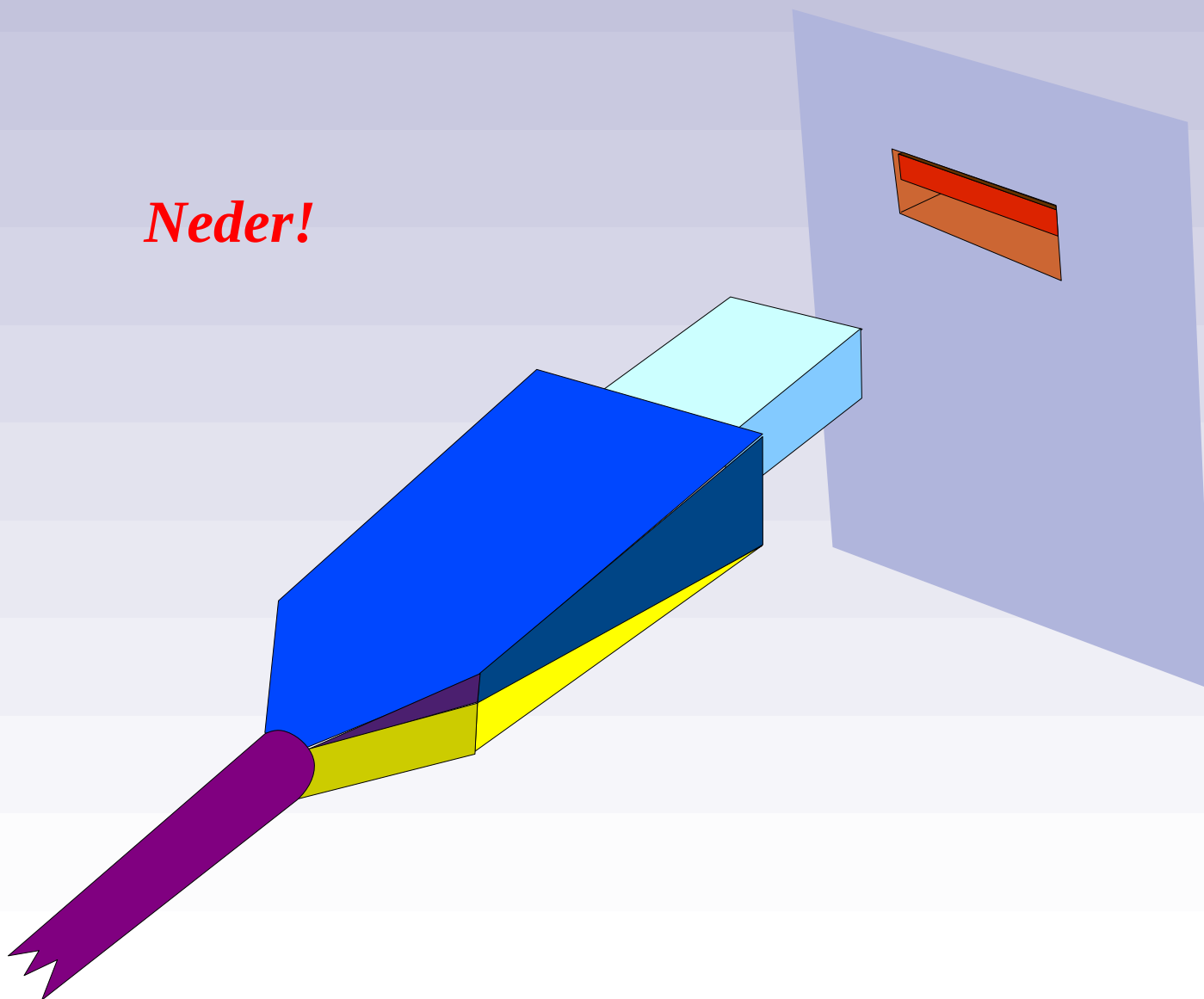

# „Daudzdimensionāli” vadi ;-)

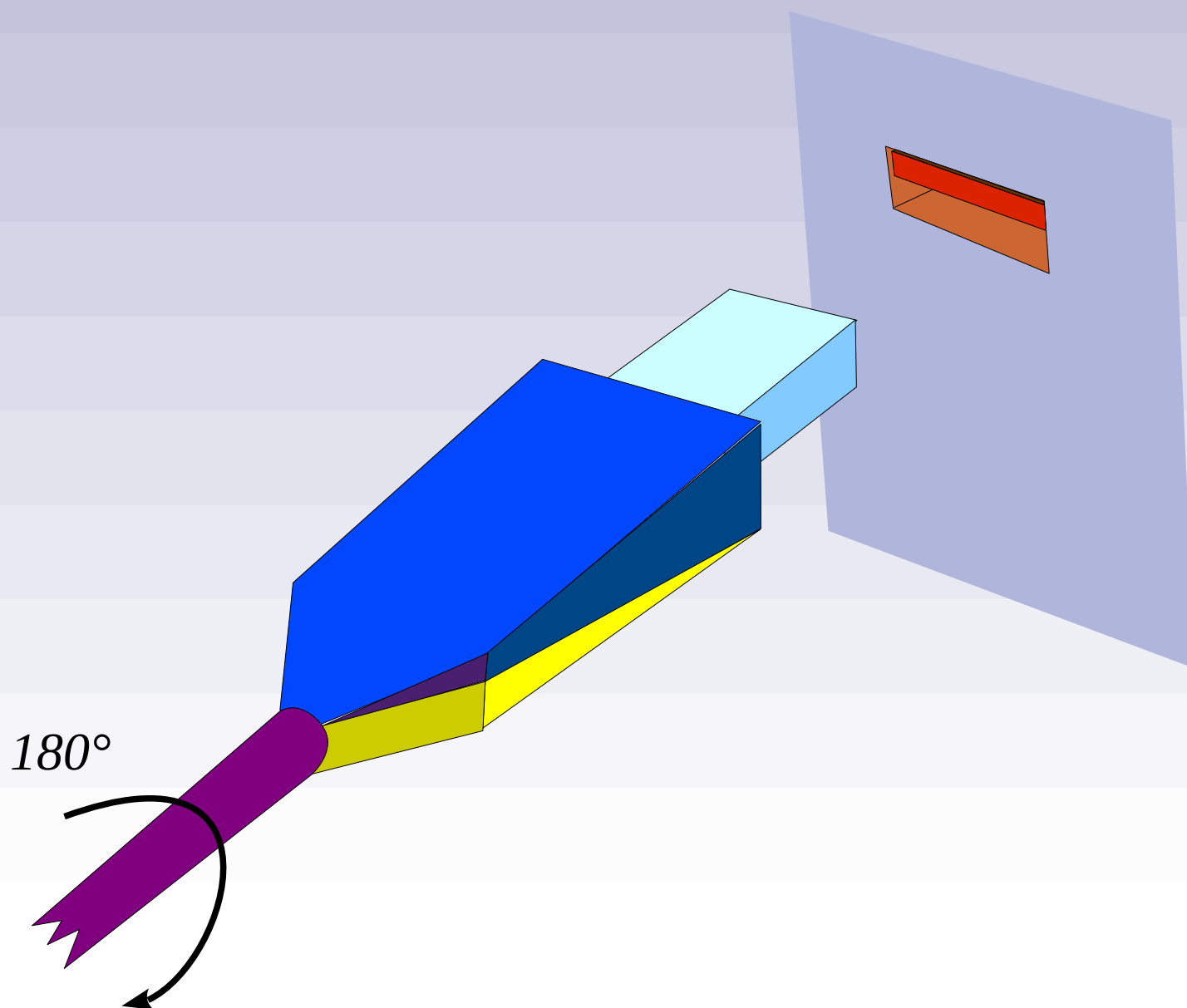

# „Daudzdimensionāli” vadi ;-)

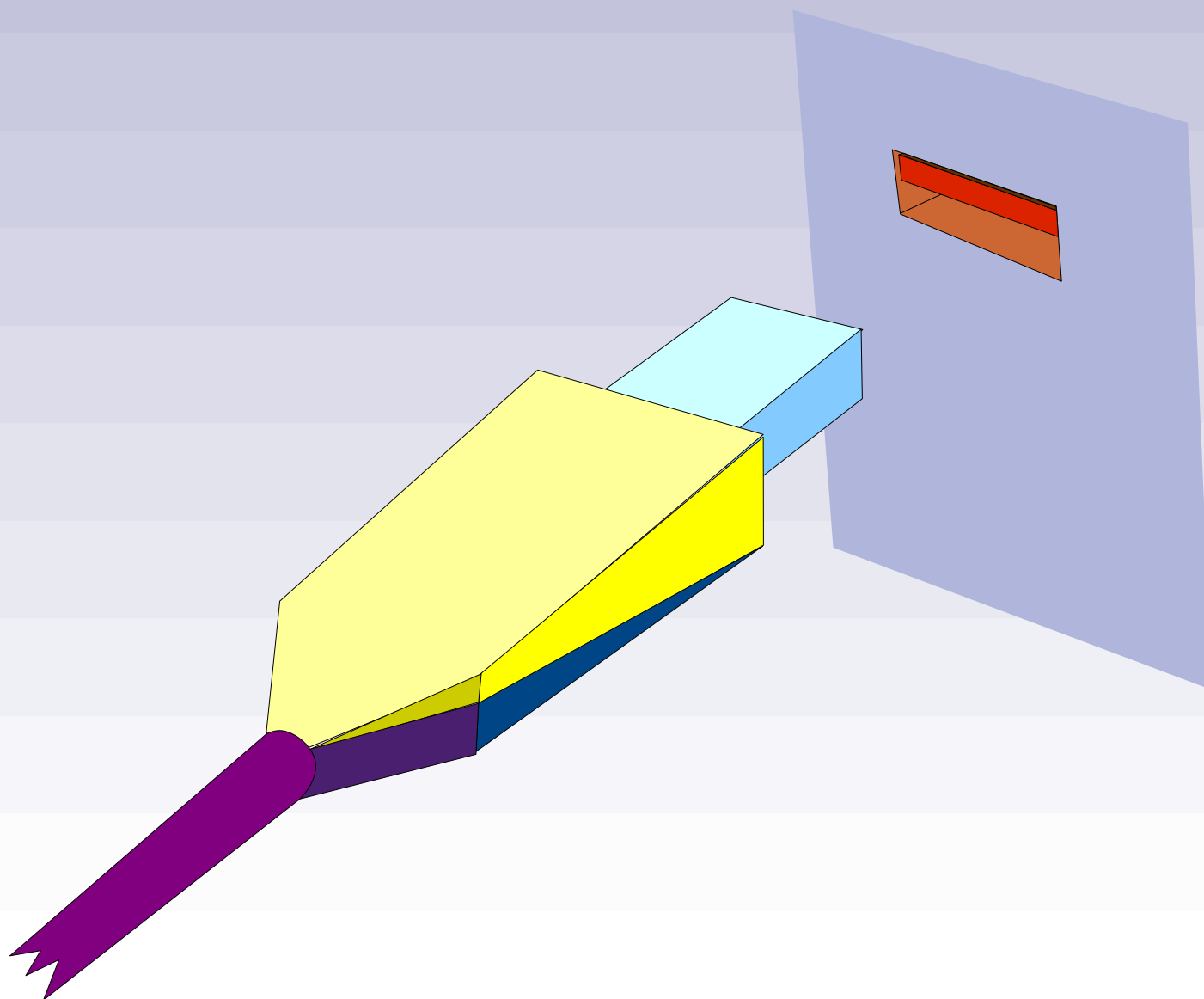

# „Daudzdimensionāli” vadi ;-)

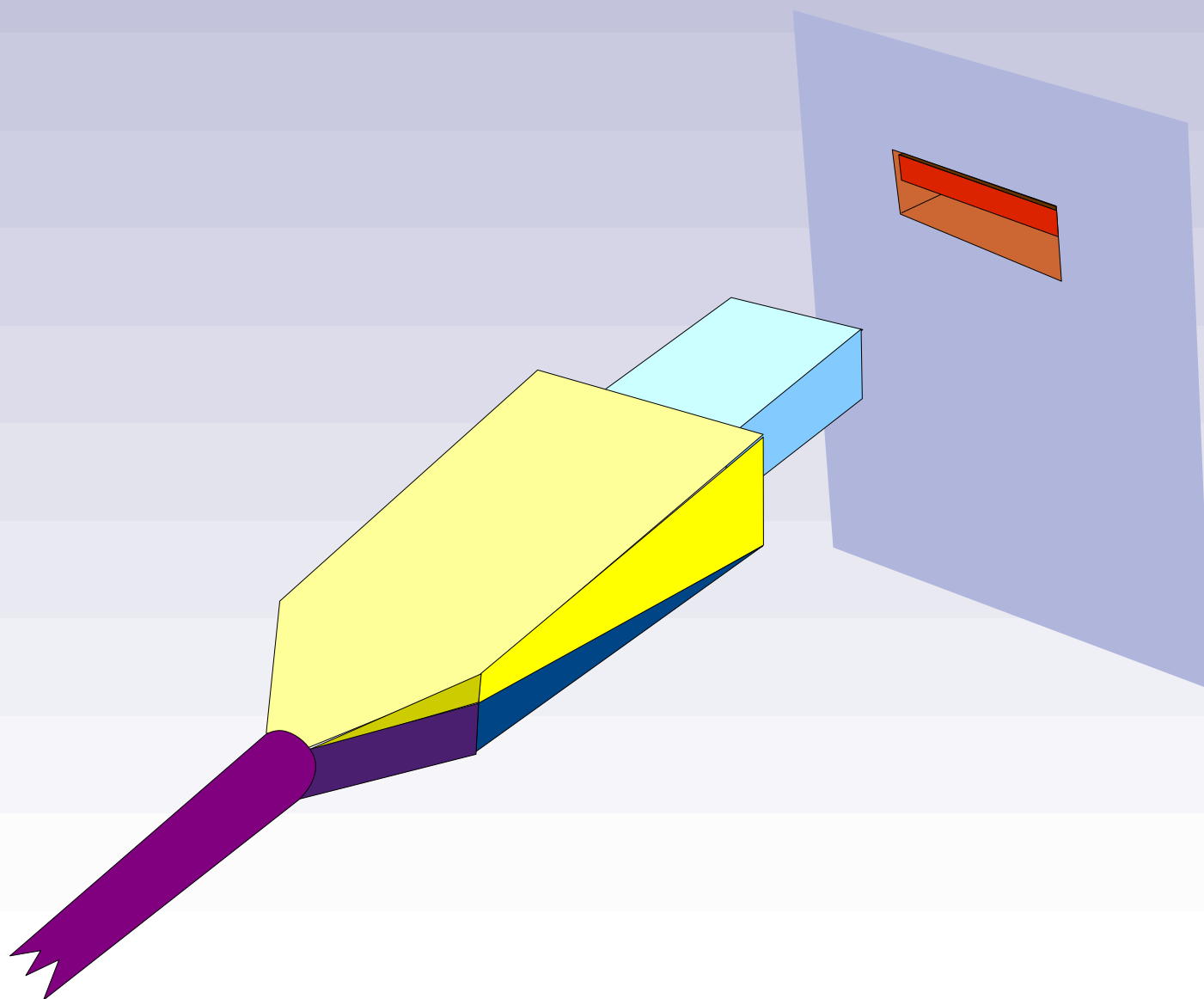



# „Daudzdimensionāli” vadi ; -)

*Neder!*

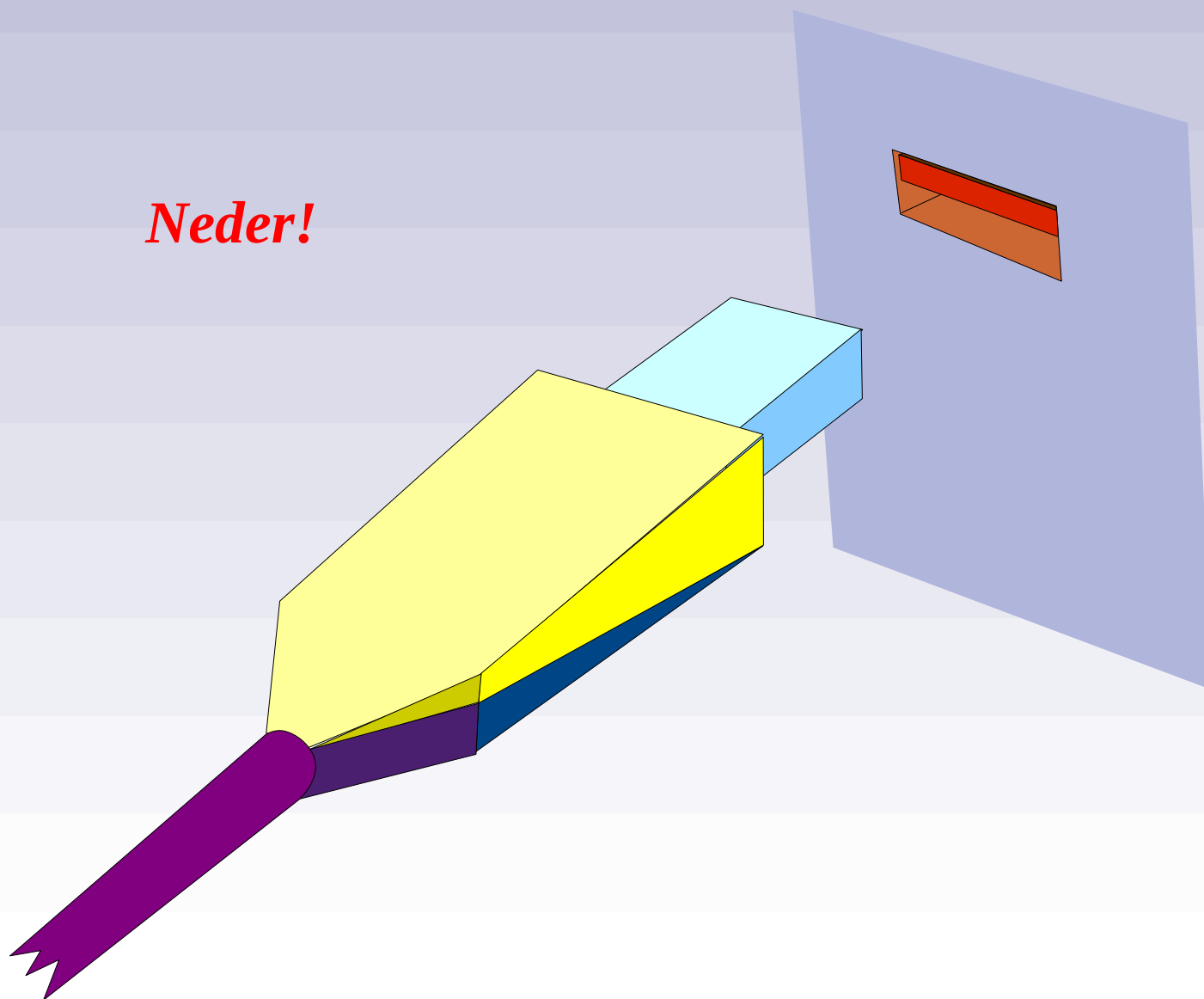

# „Daudzdimensionāli” vadi ;-)

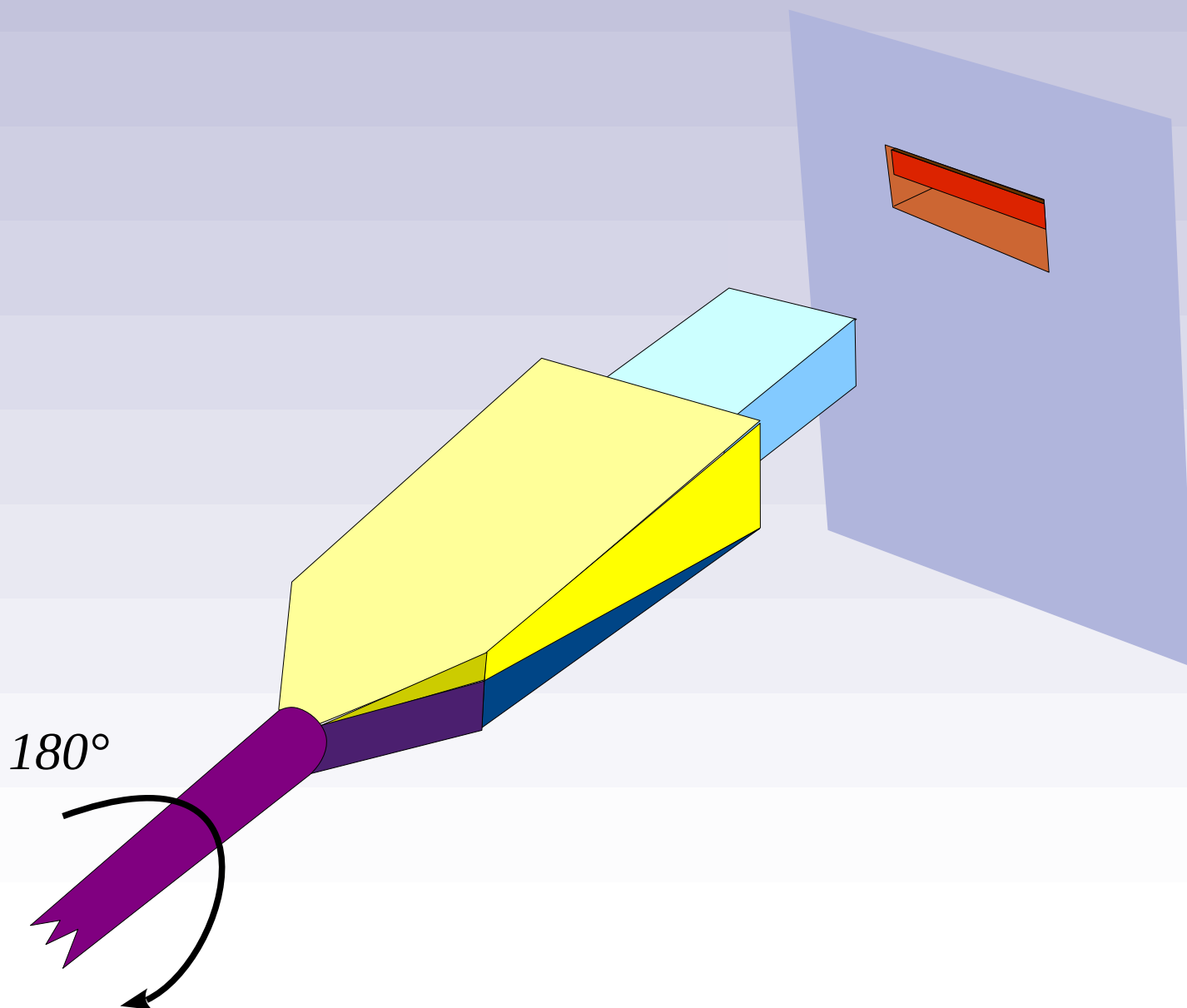

# „Daudzdimensionāli” vadi ;-)

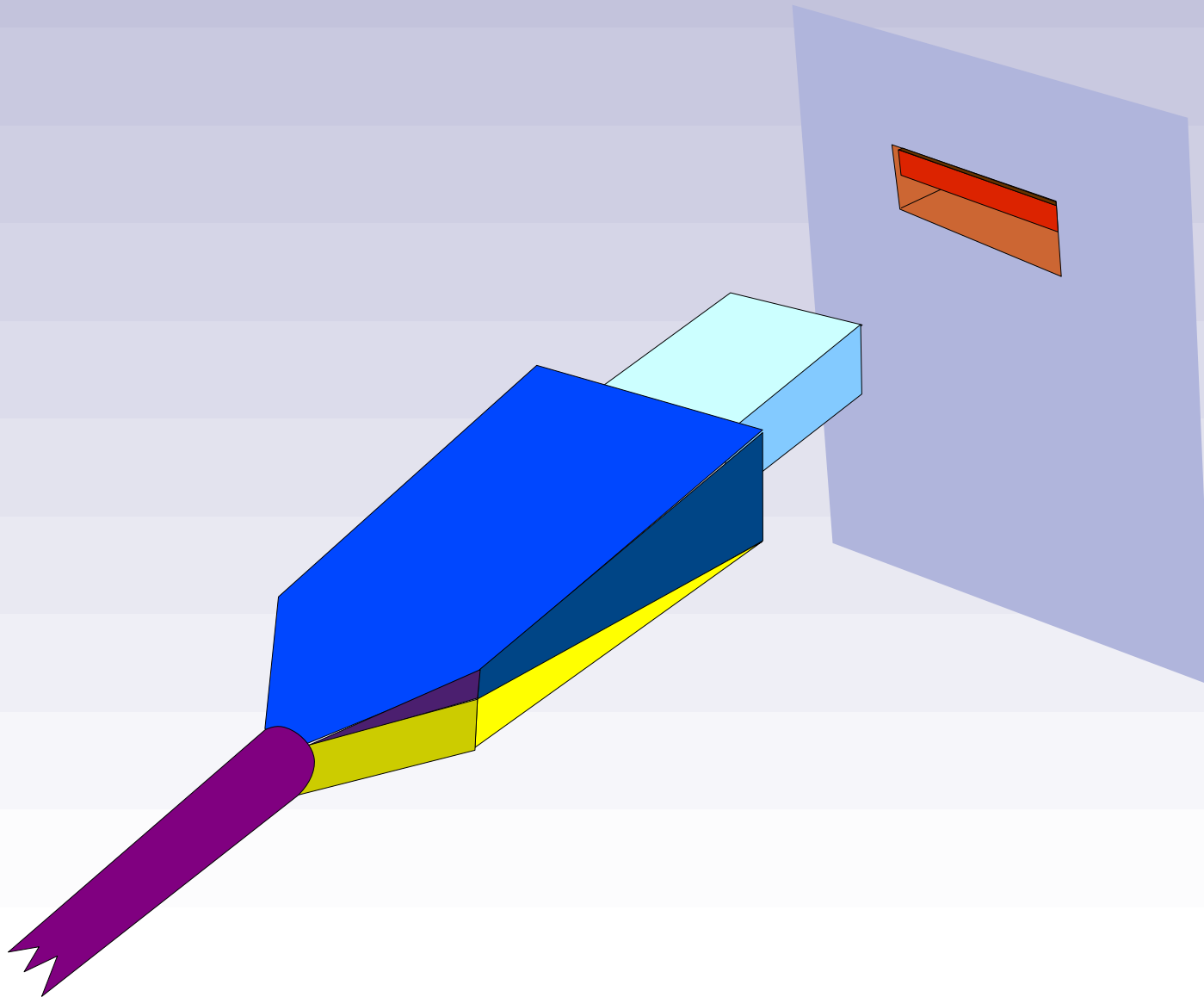

# „Daudzdimensionāli” vadi ;-)

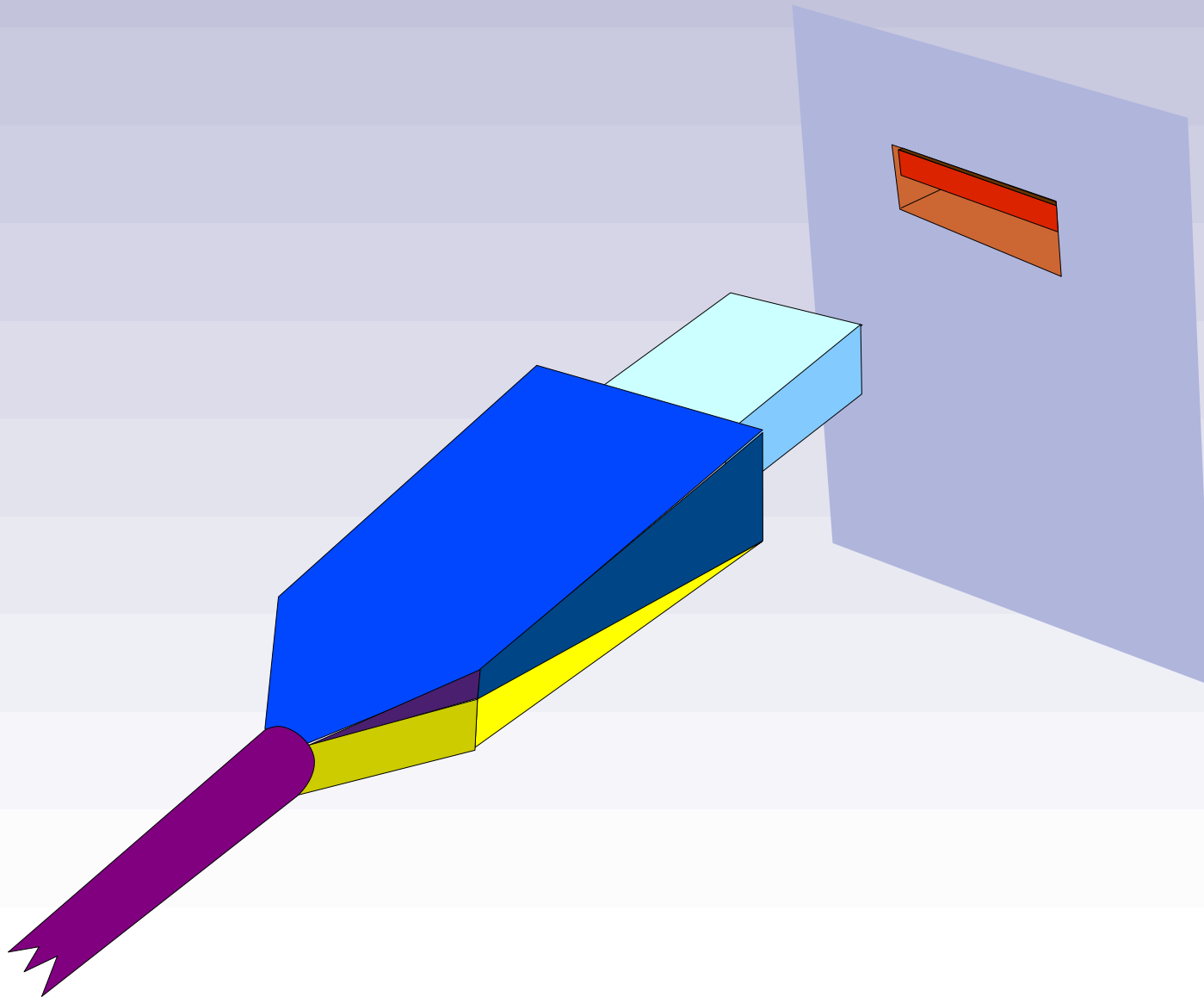

# „Daudzdimensionāli” vadi ;-)

*Der!*

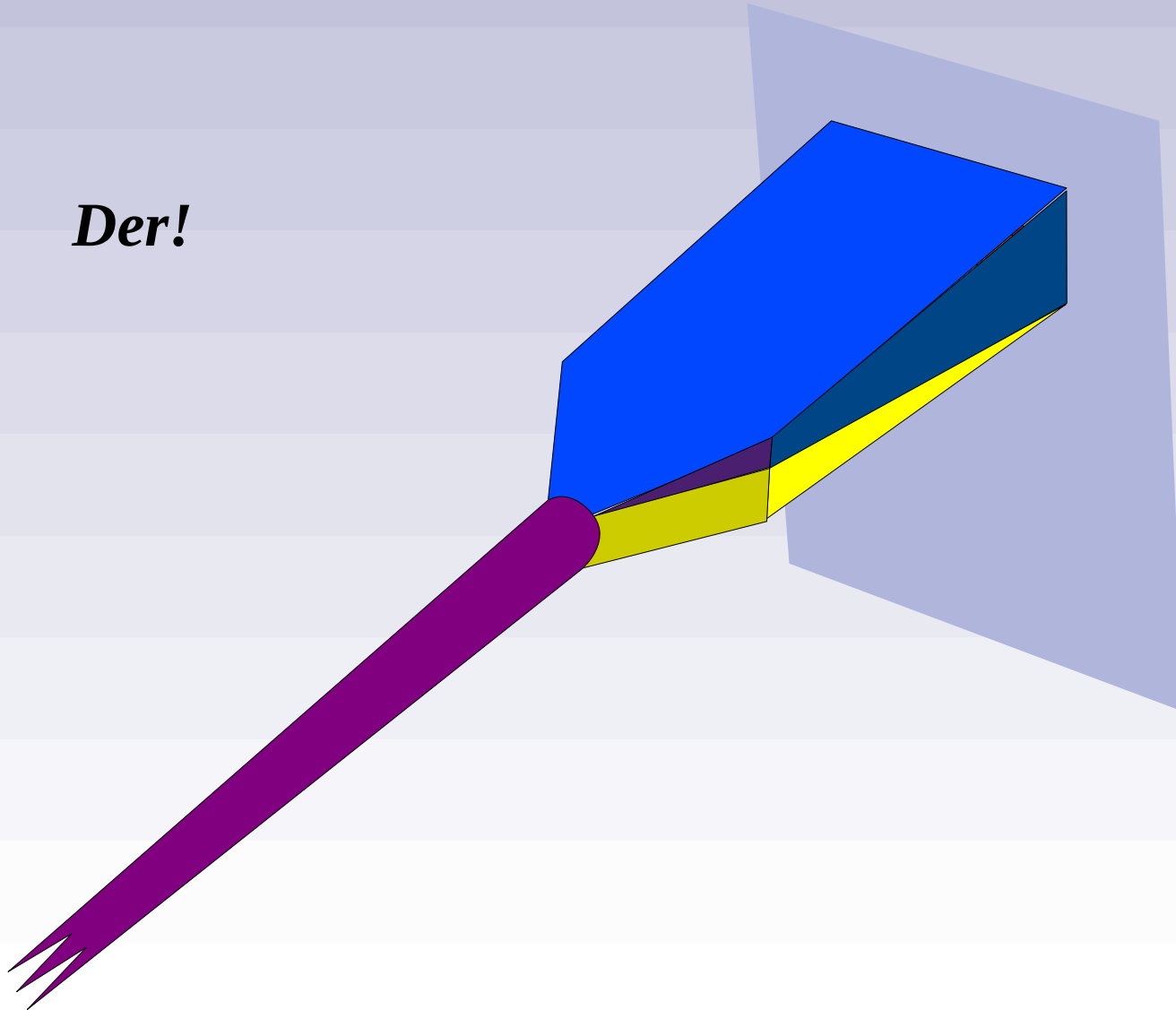

# Paldies par uzmanību!